

A30B

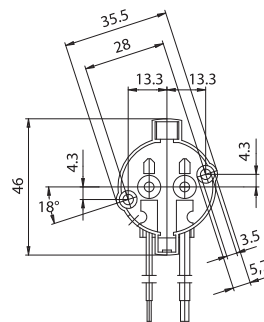

A30C

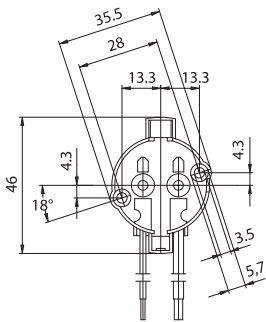
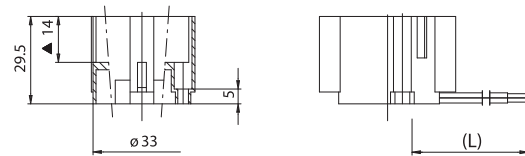
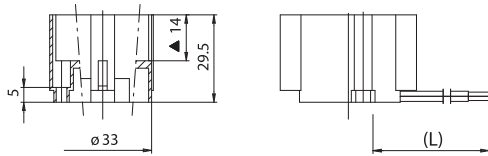

▲ Reference plane

▲ Reference plane

A30B: lampholder as A30 with PG12-2 cap.

- Weight of the lampholder in standard execution: 25 g.
- Instructions to fix the lampholder on structures.

A30C: lampholder as A30 with PG12-3 cap.

- Weight of the lampholder in standard execution: 25 g.
- Instructions to fix the lampholder on structures.

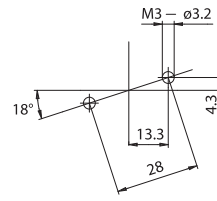
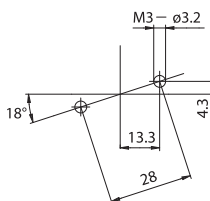

- Fixing of the lampholders pair by M3 screws, maximum head diameter 5,6 mm, to be inserted in the fixing holes with center distance 28 mm.

- Fixing of the lampholders pair by M3 screws, maximum head diameter 5,6 mm, to be inserted in the fixing holes with center distance 28 mm.

A30

1989



Lampholder:

PG12-1

Rated voltage: **500 V**
 Impulse voltage: **5 kV**
 Rated current: **2 A**
 Working temperature: **T 210°C**
 Connected cables working temperature: **T 105°÷ 250°C**
 Overvoltage category: **III**
 Protection degree (IP): **IP20**
 In conformity to the standards: **EN 60838-1**
 In conformity to the requirements of the directive: **2014/35/EU**

Approval marks:



Single-conductor, flexible connecting cables crimped to the lampholder:

Insulation	T in °C	Conduct.	Available sections and tensions			
			Pulse kV	0,75 mm ²	1,00 mm ²	1,50 mm ²
Oversize silicone <i>Single insulation</i>	180	CuSn	10kV		•	
Oversize silicone <i>Single insulation</i>	180	CuSn	5kV	•	•	
Silicone+Silicone <i>Single insulation</i>	180	CuSn	5kV	•	•	
Oversize PTFE <i>Single insulation</i>	250	CuNi	5kV		•	
Oversize PTFE +PFA <i>Double insulation</i>	250	CuNi	5kV		•	

On customer's request, the cable not subjected to the lamp starter voltage, can be supplied with basic insulation.

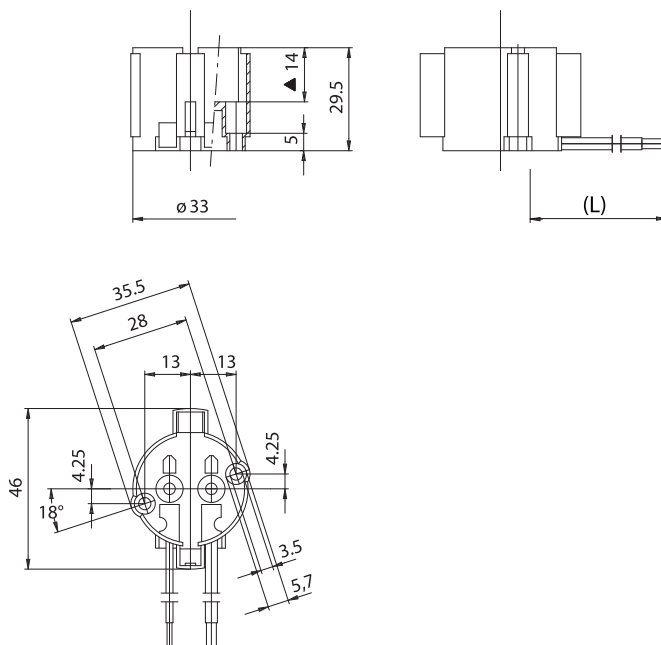

▲ Reference plane



LAMPHOLDERS FOR DISCHARGE LAMPS

A30



- Black PPS body.
Contacts in nickel-plated phosphorous bronze.
Lamp retaining springs in stainless steel.
- Weight of the lampholder in standard execution (with cables L = 25 cm): 25 g.

- Instructions to fix the lampholder on structures.

- Fixing of the lampholders pair by M3 screws, maximum head diameter 5,6 mm, to be inserted in the fixing holes with center distance 28 mm.

Lampholder:	PG12-1
Maximum power:	660 W
Rated voltage:	600 V
Impulse voltage:	5 kV
Working temperature:	T 200°C
Connected cables working temperature:	T 105° ÷ 250°C
In conformity to the standards:	UL 496 CSA 22.2 N.43
Approval marks:	cURus

Single-conductor flexible connecting cables, polarized black and white, crimped to the lampholder:

Insulation	T in °C	Conduct.	Available voltages and AWG	
			600V	18AWG
Silicone <i>Single insulation</i>	200	CuSn	•	•
Silicone+glass-braid <i>Single insulation</i>	200	CuSn	•	•
PTFE <i>Single insulation</i>	250	CuNi	•	•
PTFE+PFA <i>Double insulation</i>	250	CuNi	•	•

Attention: in the end product the cables connected to this lampholder should not be accessible during the normal replacement operations of the lamp (if accessible a cord-grip device should be provided).

